

# Part Number System for Displays

## PACKAGE DIMENSION

**E20561**

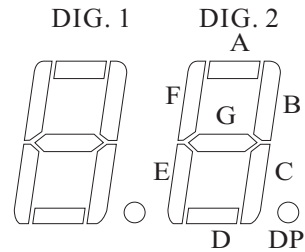
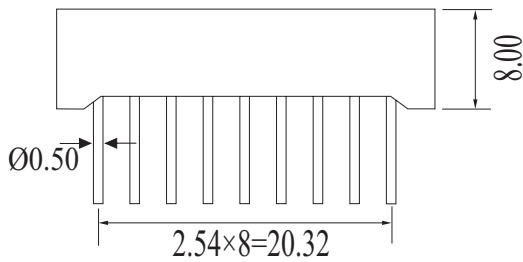
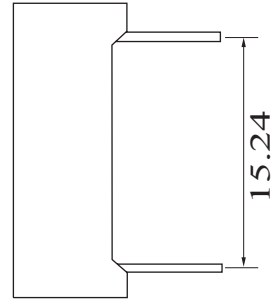
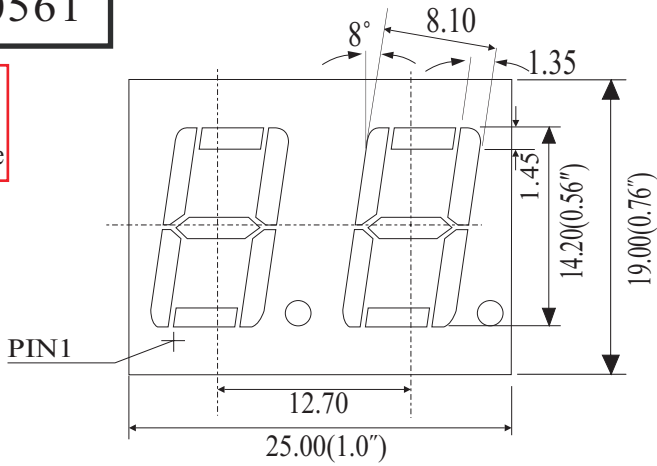

UNIT: MM(INCH) TOLERANCE:  $\pm 0.25(0.01)$ "

## INTERNAL CIRCUIT DIAGRAM

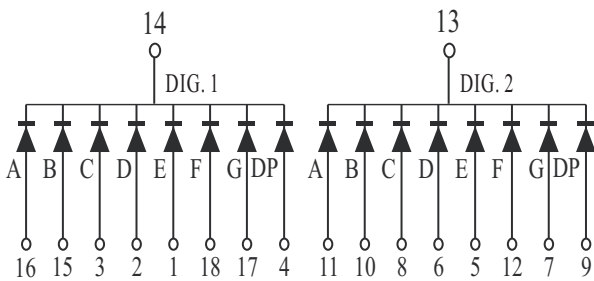

CODE J

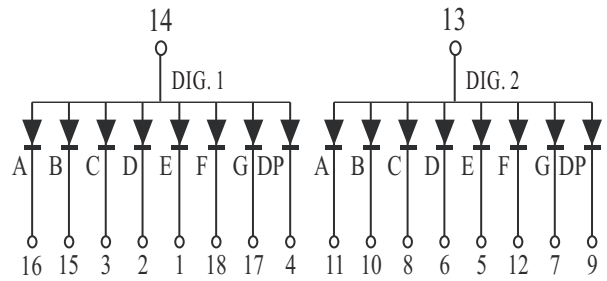

CODE G

## CODE UR

Chip Material: AlGaInP / GaAs Ultra Bright Red LED Chip



### ABSOLUTE MAXIMUM RATINGS (Ta = 25°C)

PARAMETER	SYMBOL	MAXIMUM RATING	UNIT
Power Dissipation	P <sub>D</sub>	72	mW
Peak Forward Current (1/10 Duty Cycle, 0.1 Ms Pulse Width)	I <sub>PEAK</sub>	90	mA
DC Forward Current	I <sub>F</sub>	30	mA
Reverse Voltage	V <sub>R</sub>	5	V
Operating Temperature Range	T <sub>A</sub>	-40°C to +85°C	
Storage Temperature Range	T <sub>STG</sub>	-40°C to +85°C	
Solder temperature 1/16 inch below seating plane for 3 seconds at 260°C			

### ELECTRICAL OPTICAL CHARACTER AND CURVES (Ta = 25°C)

PARAMETER	SYMBOL	MIN	TYP	MAX	UNIT	LOCATION	TEST CONDITION
Forward Voltage	V <sub>F</sub>	-	2.10	2.40	V	Per Chip	I <sub>F</sub> = 20mA
Luminous Intensity	I <sub>v</sub>	58.0	68.0	74.0	mcd	Per Chip	I <sub>F</sub> = 20mA
Peak Emission Wavelength	λ <sub>p</sub>	-	645	-	nm	Per Chip	I <sub>F</sub> = 20mA
Dominant Emission Wavelength	λ <sub>d</sub>	626	631	636	nm	Per Chip	I <sub>F</sub> = 20mA
Spectral Line Half-Width	Δλ <sub>1/2</sub>	-	20	-	nm	Per Chip	I <sub>F</sub> = 20mA
Capacitance	C	-	95	-	pF	Per Chip	V <sub>F</sub> = 0V; f = 1MHz
Reverse Current	I <sub>R</sub>	-	-	10	uA	Per Chip	V <sub>R</sub> = 5V

**Note:**

1. Luminous intensity tolerance is ±10%;
2. Dominant Emission Wavelength tolerance is ±5%.

# CODE UR

## ■ Typical Electro-Optical Characteristic Curve:

FIG. 1 Forward Current Vs. Forward Voltage

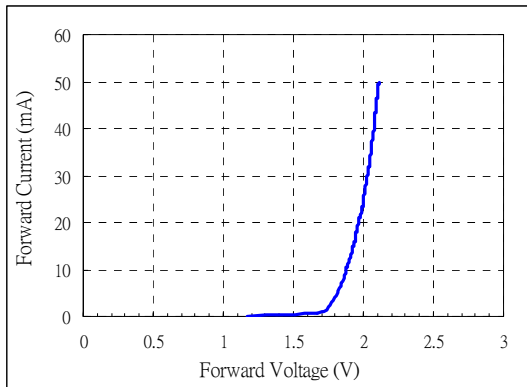

FIG. 2 Relative Intensity Vs. Forward Current

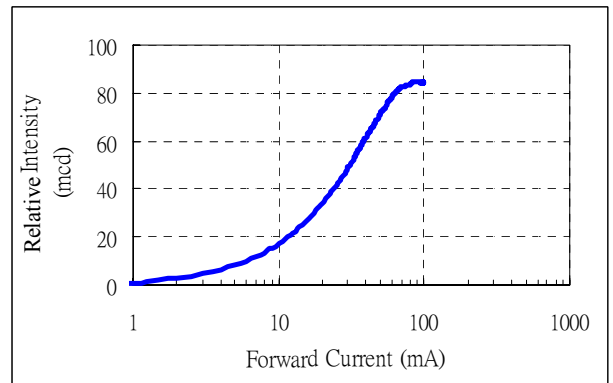

FIG. 3 Forward Voltage Vs. Temperature

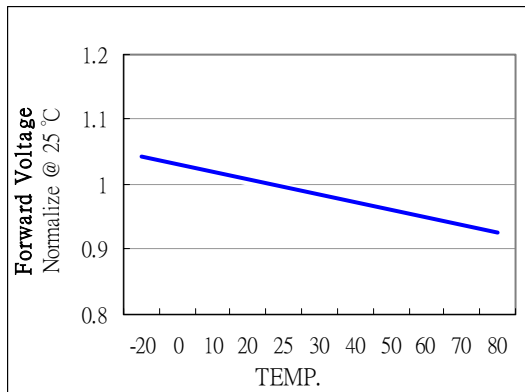

FIG. 4 Relative Intensity Vs. Temperature

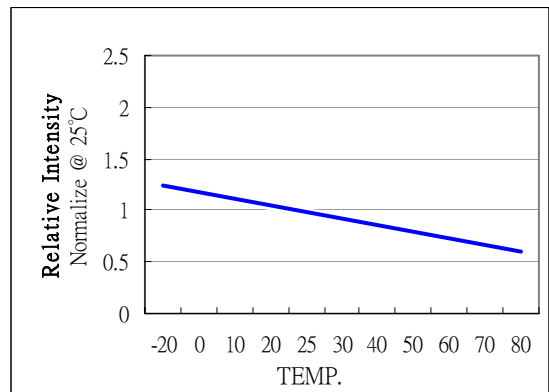

FIG. 5 Relative Intensity Vs. Wavelength

