









Classification	Embedded Microcontrollers		
			Coming Soon
Description	ATMEGA8-16AU	ATMEGA8A-AU	
			
Description	ATMEGA8A-PU	ATMEGA8L-8AU	ATMEGA16L-8AU
			Coming Soon
Description	ATXMEGA32A4U-AU	ATMEGA32A-AU	







start here

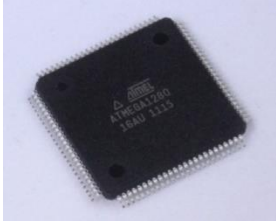

Classification	Embedded Microcontrollers		
		Coming Soon	
Description	ATMEGA48PA-AU	ATMEGA64A-MU	ATMEGA128A-AU
	Coming Soon		
Description	ATMEGA128A-MU	ATMEGA162-16AU	ATMEGA162-16PU
			
Description	ATMEGA168-20AU	ATMEGA168PA-AU	ATMEGA169PA-AU

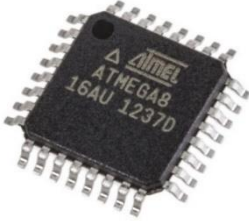



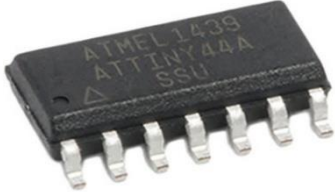



start here



Classification	Embedded Microcontrollers		
			
Description	ATMEGA644PA-AUR	ATMEGA1280-16AU	ATMEGA2560-16AU
			
Description	ATMEGA8535A-16AU	ATTINY13A-SU	ATTINY24A-SSU
			Coming Soon
Description	ATTINY26L-8PU	ATTINY44A-SSU	AT24C128C-SSHM-T

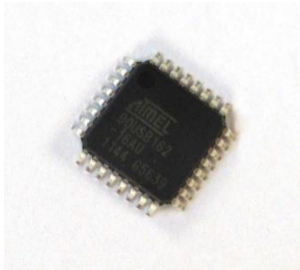







start here



Classification	Embedded Microcontrollers		
			
Description	AT89C2051-24PU	AT89S52-24AU	AT89S52-24PU
			
Description	AT90CAN128-16AU	AT90USB162-16AU	AT90USB1287-AU
			
Description	AT91M40800-33AU	AT91M55800A-33AU	AT91R40008-66AU





start here



Classification	Sensor, Transducers Temperature Compensated and Calibrated Silicon Pressure Sensors		
			
Description	MPX2010DP 10 kPa On-Chip Silicon Pressure Sensors	MPX2050DP 50 kPa On-Chip Silicon Pressure Sensors	MPX4115AP Integrated Silicon Pressure Sensor
			
Description	MPX5010DP Integrated Silicon Pressure Sensor	MPX5050DP Integrated Silicon Pressure Sensor	MPX5100DP Integrated Silicon Pressure Sensor
			
Description	MPX5700DP Integrated Silicon Pressure Sensor	MPX5999D Integrated Silicon Pressure Sensor	MPXH6115AC6U, 15 to 115 kPa, Integrated Pressure Sensor







start here

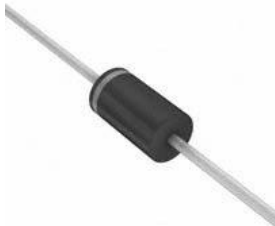

Classification	Sensor, Transducers Temperature Compensated and Calibrated Silicon Pressure Sensors		
			
Description	MPXH6400AC6U High Temperature Accuracy Integrated Silicon Pressure Sensor	MPXHZ6400AC6T1 Media Resistant and High Temperature Accuracy Integrated Silicon Pressure Sensor	MPXM2053GS 50 kPa On-Chip Temperature Compensated and Calibrated Silicon Pressure Sensors
			
Description	MPXV4006DP Integrated Silicon Pressure Sensor	MPXV7007DP Integrated Silicon Pressure Sensor	

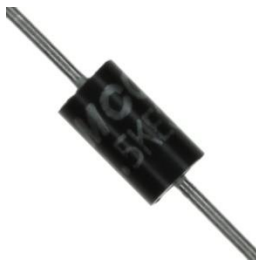
start here



Classification	Diodes		
			
Description	1.5KE15A	1.5KE200A	1.5KE30A
			
Description	1.5KE36A	1.5KE39CA	1.5KE440CA
			
Description	1.5KE51CA	1.5KE75A	1N4746A

start here









Website: www.advancepanda.com

Office address: RmA00,5th Floor,Hua Yun Building-1,

Zhen Xing Rd.,FutianDistrict,Shenzhen City,China.



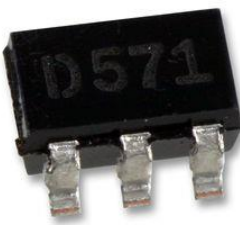





Tel:+852-65782642

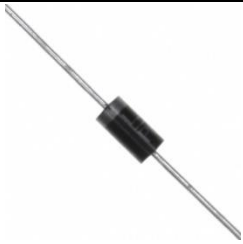

Classification	Diodes		
			
Description	1N5248B-TAP	BAP50-03	BAS85
			
Description	BYV26C-TAP	BYV26E-TAP	BZM55C5V1
			
Description	DS9503P	HFA08SD60STRPBF	HFA08TB60PBF

start here



Classification	Diodes		
			
Description	HFA30TA60CSTRLPBF	M2LZ47	M7 diode
			
Description	P6KE100CA	P6KE12A	P6KE16A
			
Description	P6KE18CA	P6KE200A	P6KE20A

start here

Website: www.advancepanda.com

Office address: RmA00,5th Floor,Hua Yun Building-1,

Zhen Xing Rd.,FutianDistrict,Shenzhen City,China.

Tel:+852-65782642





Classification	Diodes		
			
Description	P6KE22A	P6KE7.5CA	PESD1CAN
			
Description	PESD5V0S1BL,315	SMAJ10A	SMAJ12A
			
Description	SMCJ33A-TR	STTH1002CT	STTH1602CT

start here











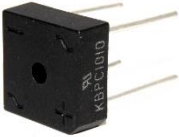

Classification	Diodes		
			
Description	STTH2002CFP	STTH30R04D	VS-40EPS12PBF

start here



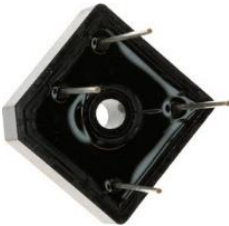



Classification	Bridge Rectifiers		
			
Description	DB107	DB107S	KBL408
			
Description	KBPC1010	KBPC1510	KBPC1510W
			
Description	KBPC2510	KBPC2510W	KBPC3510

start here



Classification	Bridge Rectifiers		
			
Description	KBPC5010	KBPC5010W	KBU1510
			
Description	MB10M	QL100	RB157

start here





Website: www.advancepanda.com

Office address: RmA00,5th Floor,Hua Yun Building-1,

Zhen Xing Rd.,FutianDistrict,Shenzhen City,China.

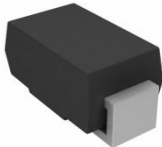







Tel:+852-65782642



Classification	Rectifiers		
			
Description	10A10	10MQ100NTRPBF	12CWQ04FNTRPBF
			
Description	12CWQ10FNTRPBF	16CTQ100PBF	19TQ015PBF
			
Description	1N4007	1N4148.133	20CTH03PBF



start here



Classification	Rectifiers		
			
Description	20CTQ150PBF	30CPQ060PBF	30CPQ150PBF
			
Description	30CTQ060PBF	30CTQ100PBF	40CPQ045PBF
			
Description	40CPQ060PBF	40CPQ100PBF	40L15CTPBF







start here

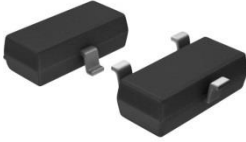

Classification	Rectifiers		
			
Description	60CPU02-F	60CTQ150PBF	63CPQ100PBF
			
Description	63CTQ100PBF	6CWQ10FNTRPBF	8E2TX06-E
			
Description	BAS16VY.115	BAS21VD,135	BAS40-05

start here

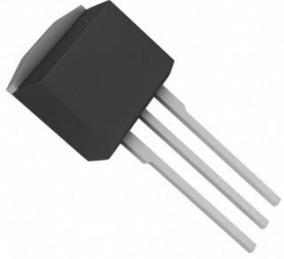

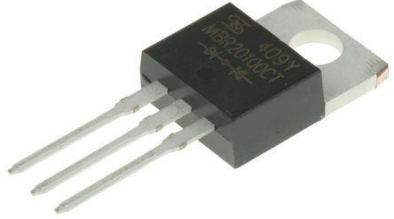



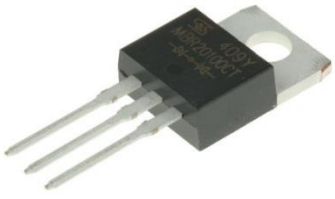

Classification	Rectifiers		
			
Description	BAT54S,215	BAV70	BAV99
			
Description	BAV99S	BAW56,215	BYV34-500.127
			
Description	BYV42E-200.127	ES1D-E3 61T	MBR20100CT

start here



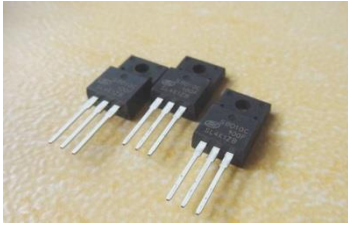
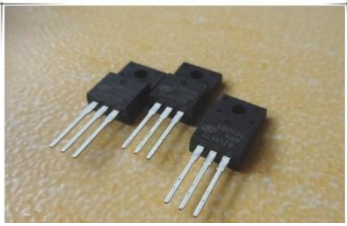

Classification	Rectifiers		
			
Description	MBR20100CTG	MBR2045CT	MBR6045WTPBF
			
Description	MBRF20100CT	MBRF20100CT	MUR460-E3 54
			
Description	S3D-E3 57T	SBD10C100F	SBD10C100T

start here







Website: www.advancepanda.com

Office address: RmA00,5th Floor,Hua Yun Building-1,

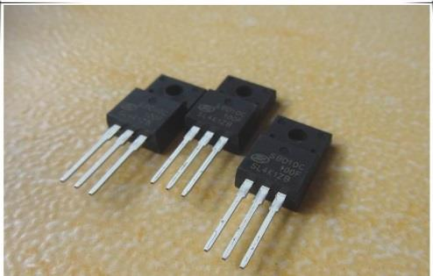
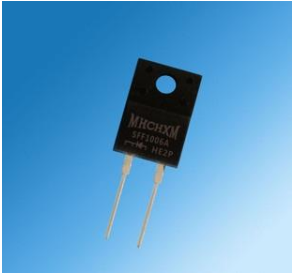
Zhen Xing Rd.,FutianDistrict,Shenzhen City,China.

Tel:+852-65782642

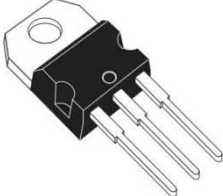









Classification	Rectifiers		
			
Description	SBD10C100T-1	SBD10C150T	SBD20C100T
			Coming Soon
Description	SBYV26C-E3 54	SL23-E3 52T	SR2100
			
Description	STPS20150CT	STPS20170CT	STPS2045CTC

start here



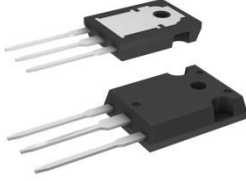







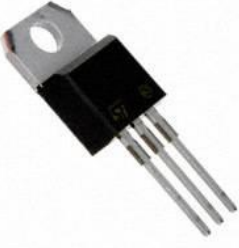

Classification	Rectifiers		
			
Description	STPS20H100CT	STPS20S100CT	STPS2L60A
			
Description	STPS30120CT	STPS30150CT	STPS3045CT
			
Description	STPS30H100CT	STPS30H100CW	STPS30H60CFP



start here



Classification	Rectifiers		
			
Description	STPS30L30CT	STPS30L45CT	STPS30L45CW
			
Description	STPS4045CW	STPS40H100CW	STPS40L45CT
			
Description	STPS41H100CT	STPS5L40	STPS6045CW

start here

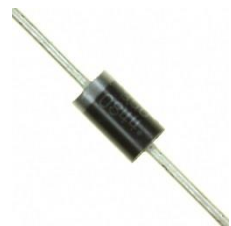

Classification	Rectifiers		
			
Description	STPS61150CW	STPS61L45CW-H	STPS61L60CW
			
Description	STTH12R06D	STTH15R06D	STTH2003CFP
			
Description	STTH3L06U	STTH4L06RL	STTH4L06RL







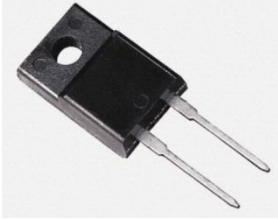

start here

Website: www.advancepanda.com

Office address: RmA00,5th Floor,Hua Yun Building-1,
Zhen Xing Rd.,FutianDistrict,Shenzhen City,China.

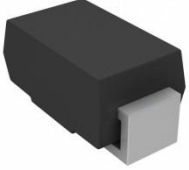







Tel:+852-65782642

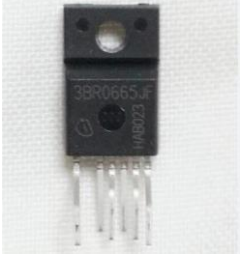

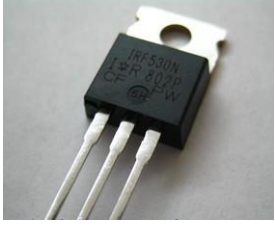
Classification	Rectifiers		
			
Description	STTH6003CW	STTH8L06FP	STTH8R06D
			
Description	STTH8R06FP	STTH8S06D	VS-15MQ40NTRPBF
			
Description	VS-42CTQ030STRLPBF	VS-ETX0806-M3	VS-ETX0806FP-M3

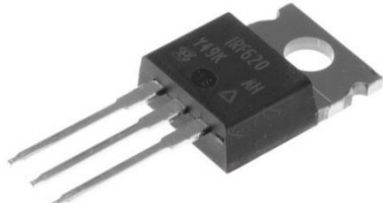
start here



Classification	Transistor		
			
Description	2SK2962	ICE3BR1065JF	IRF520PBF
			
Description	IRF530NPBF	IRF530PBF	IRF620PBF
			
Description	IRF630NPBF	IRF634PBF	IRF640PBF

start here







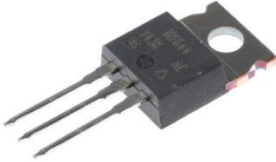

Website: www.advancepanda.com

Office address: RmA00,5th Floor,Hua Yun Building-1,

Zhen Xing Rd.,FutianDistrict,Shenzhen City,China.

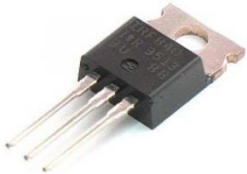



Tel:+852-65782642



Classification	Transistor		
			
Description	IRF644PBF	IRF730PBF	IRF740PBF
			
Description	IRF830APBF	IRF830PBF	IRF840
			
Description	IRF840APBF	IRF840PBF	IRF9530PBF

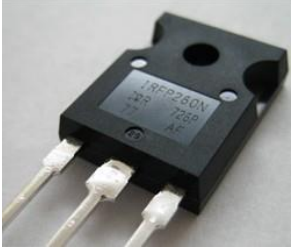
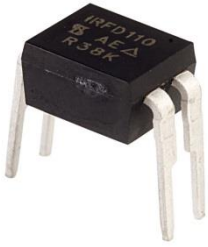
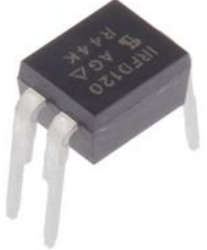
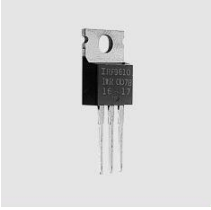

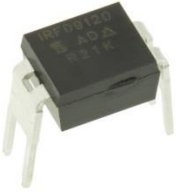

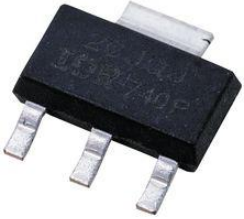

start here

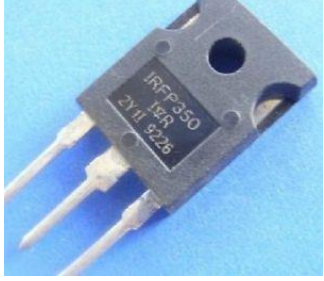

Classification	Transistor		
			
Description	IRFB20N50KPBF	IRFD110PBF	IRFD120PBF
			
Description	IRFB9N65APBF	IRFBE30PBF	IRFBG30PBF
			
Description	IRFD9120PBF	IRFL110TRPBF	IRFL210TRPBF

start here

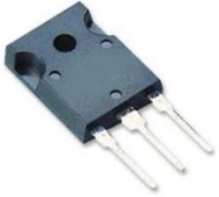
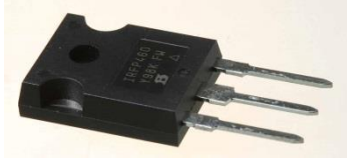

Classification	Transistor		
			
Description	IRFP264PBF	IRFP350PBF	IRFP360PBF
			
Description	IRFP450APBF	IRFP450PBF	IRFP460APBF
			
Description	IRFP460LCPBF	IRFP460PBF	IRFP9240PBF







start here

Website: www.advancepanda.com

Office address: RmA00,5th Floor,Hua Yun Building-1,
Zhen Xing Rd.,FutianDistrict,Shenzhen City,China.

Tel:+852-65782642



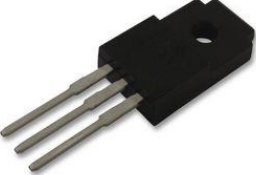
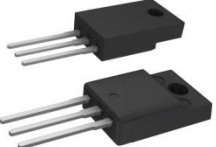







Classification	Transistor		
			
Description	IRFPS37N50APBF	IRFR9220TRPBF	IRFU430APBF
			
Description	IRFZ44NPBF	SIHG20N50C-E3	STF20NM65N
			
Description	STF22NM60N	STF26NM60N	STF28NM50N

start here



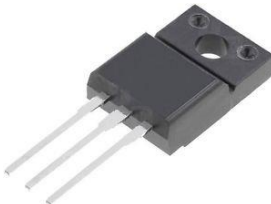

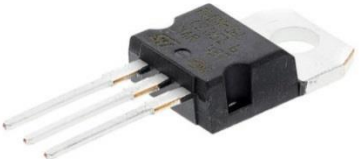







Classification	Transistor		
			
Description	STP10NK60ZFP	STP12NM50FP	STP22NM60N
			
Description	STP26NM60N	STP28NM50N	STP4NK60ZFP
			
Description	STP4NK80ZFP	STP5NK50Z	STP60NF06L

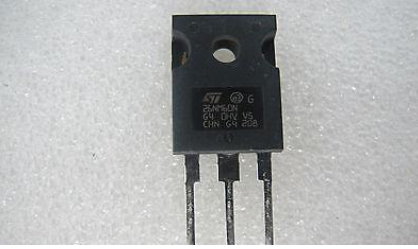
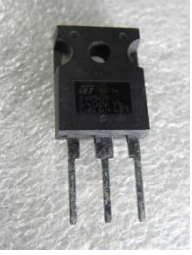







start here

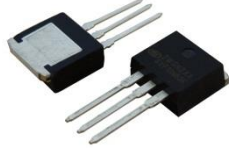

Classification	Transistor		
			
Description	STP6NK60ZFP	STP9NK50ZFP	STW19NM50N
			
Description	STW24NM65N	STW26NM60N	STW34NM60N
			
Description	STW45NM60	STW48NM60N	STW9NK90Z

start here

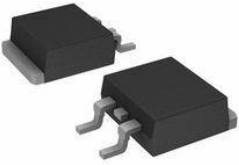

Classification	Transistor		
			
Description	SVF10N60F	SVF10N65F	SVF12N60F
			
Description	SVF12N65F	SVF1N60B	SVF1N60M(S)
			
Description	SVF2N60D	SVF2N60F	SVF2N60M(S)

start here







Website: www.advancepanda.com

Office address: RmA00,5th Floor,Hua Yun Building-1,





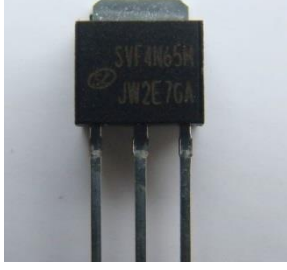
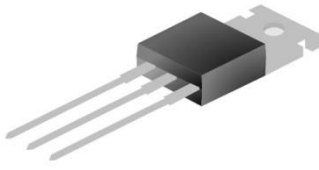

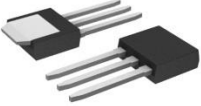
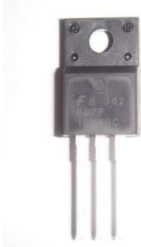

Zhen Xing Rd.,FutianDistrict,Shenzhen City,China.

Tel:+852-65782642



Classification	Transistor		
			
Description	SVF2N60MJ	SVF2N60N	SVF2N65F
			
Description	SVF2N70MJ	SVF3N80F	SVF4N60D
	 TO-220-3L		
Description	SVF4N60F	SVF4N65F	SVF4N65M(S)



Classification	Transistor		
			
Description	SVF4N65MJ	SVF4N70F	SVF4N90F
			
Description	SVF5N60F	SVF6N60F	SVF6N70MJG
			
Description	SVF7N60F	SVF7N65F	SVF7N80F

start here





Website: www.advancepanda.com

Office address: RmA00,5th Floor,Hua Yun Building-1,

Zhen Xing Rd.,FutianDistrict,Shenzhen City,China.





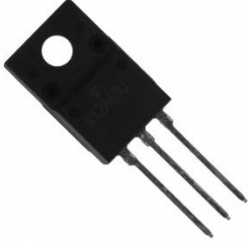
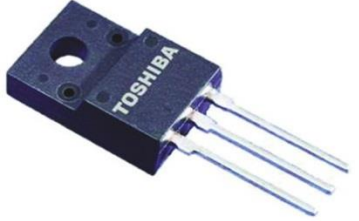



Tel:+852-65782642



Classification	Transistor		
			
Description	SVF830T	SVF8N60F	SVF8N70F
			
Description	SVF9N90F	TK12A60U	TK6A65D

start here



Classification	Integrated Circuits (ICs)		
			
Description	2SD1556-TO-3PF-D1556	BTA16-800BRG	DS18B20+
			
Description	EPM240T100C5N	EPM3032ALC44-10N	EPM3064ATC100-10N
			
Description	EPM3064ATC44-10N	EPM3064ATI44-10N	EPM3128ATC100-10N









start here

Website: www.advancepanda.com

Office address: RmA00,5th Floor,Hua Yun Building-1,
Zhen Xing Rd.,FutianDistrict,Shenzhen City,China.





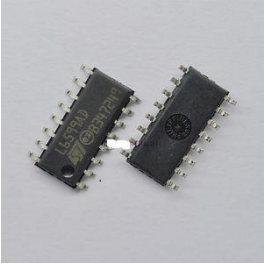



Tel:+852-65782642

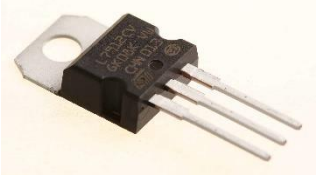

Classification	Integrated Circuits (ICs)		
			
Description	EPM3256ATC144-10N	EPM570T100C5N	FSDH321
			
Description	KA5M02659R	L4981AD013TR	L4981BD013TR
			
Description	L6561D013TR	L6562ADTR	L6599ADTR

start here



Classification	Integrated Circuits (ICs)		
			
Description	L7805CV	L7809CV	L78L05ACUTR
			
Description	L7912CV	LA7837	LA7845
			
Description	LD1117ASTR	LM2576T-ADJ	LM2904DR







start here

Website: www.advancepanda.com

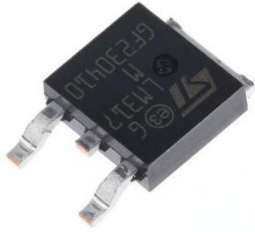
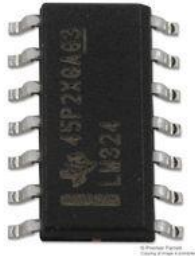
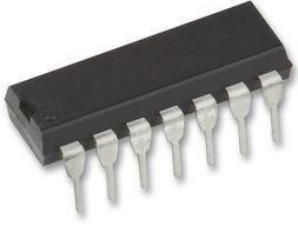
Office address: RmA00,5th Floor,Hua Yun Building-1,
Zhen Xing Rd.,FutianDistrict,Shenzhen City,China.

Tel:+852-65782642

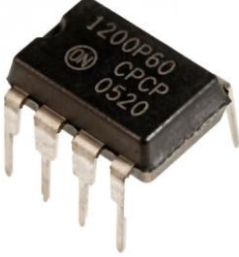

Classification	Integrated Circuits (ICs)		
			
Description	LM317MDT-TR	LM324DR	LM339DT
			
Description	LM393DT	LM5101AMX	MD1803DFX
			
Description	MPSA42	NCP1200P60	NCP1203D60







start here

Website: www.advancepanda.com

Office address: RmA00,5th Floor,Hua Yun Building-1,
Zhen Xing Rd.,FutianDistrict,Shenzhen City,China.



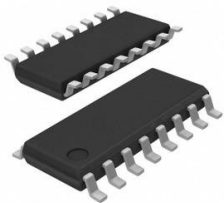
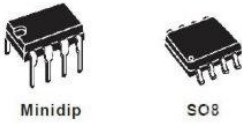





Tel:+852-65782642



Classification	Integrated Circuits (ICs)		
			
Description	PCF8574P	SA1117BH-1.5TR	SA1117BH-1.8TR
			
Description	SA1117BH-3.3TR	SA1117BH-ADJTR	SA7527S
			
Description	SD45215SA	SD45217	SD4840P67K65







start here



Classification	Integrated Circuits (ICs)		
			
Description	SD4841P67K65	SD4843P67K65	SD4844P67K65
		 SOT-23-6L	
Description	SD4870TR	SD4871	SD6804S
			
Description	SD6830	SD6832	SD6835

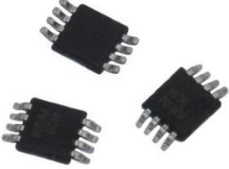
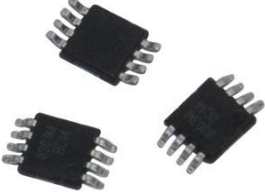
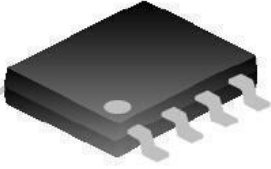







start here

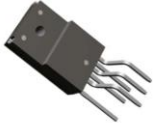

Classification	Integrated Circuits (ICs)		
			
Description	SD6863	SD6864	SD6900
			
Description	SD6901S	SD6902S	SD6904S
			
Description	SD6954	SD7530S	SD8585S









start here

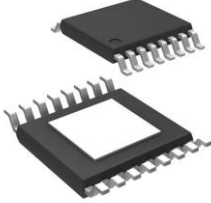

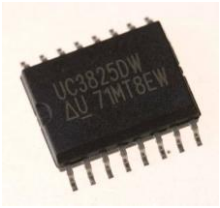
Classification	Integrated Circuits (ICs)		
			
Description	STRW5753A	STRW6262	TDA1085C
			
Description	TDA4864AJ	TDA8351	THC63LVD104C
			
Description	TL074IDR	TL431CLP	

start here



Classification	Integrated Circuits (ICs)		
			
Description	TLP281	TPS40057PWPR	UC2846N
			
Description	UC3825DWTR	UC3846N	UC3854BDWTR
			
Description	UC3854BN	UC3854DWTR	UC3854N







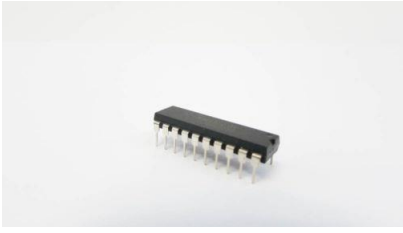

start here

Website: www.advancepanda.com

Office address: RmA00,5th Floor,Hua Yun Building-1,
Zhen Xing Rd.,FutianDistrict,Shenzhen City,China.

Tel:+852-65782642



Classification	Integrated Circuits (ICs)		
			
Description	UC3875N	UCC27201DR	UCC27324DR
			
Description	UCC28019DR	UCC28061DR	UCC28070PWR
			
Description	UCC2897APWR	UCC29002DR	UCC3818ADR





start here

Website: www.advancepanda.com

Office address: RmA00,5th Floor,Hua Yun Building-1,
Zhen Xing Rd.,FutianDistrict,Shenzhen City,China.

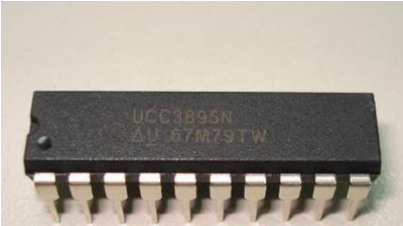
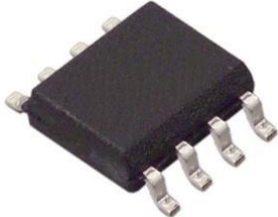
Tel:+852-65782642



Classification	Integrated Circuits (ICs)		
			
Description	UCC3895N	UCC3895PWG4	UCC3895PWTR
			
Description	VIPER12ADIP-E	VIPER22ADIP-E	

start here

Website: www.advancepanda.com

Office address: RmA00,5th Floor,Hua Yun Building-1,

Zhen Xing Rd.,FutianDistrict,Shenzhen City,China.

Tel:+852-65782642



Classification	Thermostat Temperature Control Switch		
			
Description	KSD-9700-145-NC	KSD-9700-140-NC	KSD-9700-135-NC
Description	KSD-9700-130-NC	KSD-9700-125-NC	KSD-9700-120-NC
Description	KSD-9700-115-NC	KSD-9700-110-NO	KSD-9700-110-NC
Description	KSD-9700-105-NC	KSD-9700-100-NC	KSD-9700-60-NO
Description	KSD-9700-90-NC	KSD-9700-75-NC	KSD-9700-70-NC
Description	KSD-9700-65-NC	KSD-9700-80-NC	KSD-9700-100-NO
Description	KSD-9700-135-NO	KSD-9700-105-NO	KSD-9700-145-NO
Description	KSD-9700-150-NO	KSD-9700-130-NO	KSD-9700-125-NO
Description	KSD-9700-120-NO	KSD-9700-115-NO	KSD-9700-95-NO
Description	KSD-9700-90-NO		

start here



Classification	Thermostat Temperature Control Switch		
Description	KSD301-040v	KSD301-070v	KSD301-080h
Description	KSD301-090h	KSD301-100h	KSD301-120h
Description	KSD301-200h	KSD301-120v	KSD301-115v
Description	KSD301-115h	KSD301-110v	KSD301-110h
Description	KSD301-105v	KSD301-105h	KSD301-100v
Description	KSD301-095v	KSD301-095h	KSD301-090v
Description	KSD301-080v	KSD301-070h	KSD301-060v
Description	KSD301-060h	KSD301-150v	KSD301-140v

start here

Website: www.advancepanda.com

Office address: RmA00,5th Floor,Hua Yun Building-1,

Zhen Xing Rd.,FutianDistrict,Shenzhen City,China.

Tel:+852-65782642







Classification	Rotary Switch		
Description	KNOB-PLB-14X15X6-BLUE	KNOB-PLB-14X15X6-YELLOW	Rotary Switch 37mm x 15mm
			
Description	KNOB-PLB-15X17X6-Red	KNOB-PLB-15X17X6-Green	KNOB-PLB-15X17X6-Yellow
Description	KNOB-PLB-15X17X6-BLUE	KNOB-PLB-15X17X6-Orange	KNOB-PLB-15X17X6-Black
Description	KNOB-PLB-15X17X6-GRAY	KNOB-PLB-15X17X6-White	

start here



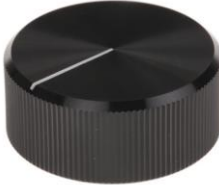









Classification	Rotary Switch		
			Coming Soon
Description	15mm Black Aluminium Push Fit knob	37mm x 15mm Potentiometer Rotary Switch Volume Digital Knob Cap Black	Aluminium Silver Pot Knobs
	Coming Soon	Coming Soon	Coming Soon
Description	Black Aluminum Rotary Control Knob 20mm	KNOB aluminium 30mm BLACK	Knob-Aluminum alloy 15*17*6mm-Black
			
Description	Knob-Aluminum alloy 15*17*6mm-Silver	Pro Potentiometer Knob, Grub Screw Type, 30mm Knob Diameter, Black, 6.4mm Shaft	Pro Potentiometer Knob, Push-On Type, 20mm Knob Diameter, Black Splined, 6mm Shaft

start here

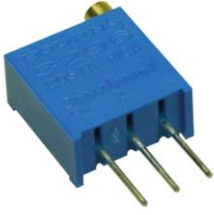

Classification	Potentiometers		
			
Description	KNOB A01	Knob A03	KNOBE A05
			
Description	3296P-1-202LF Trimmer	3296W- 5K Trimmer	3296X-103 10k Trimmer
			
Description	3296W 2k2 Trimmer	3296W 1k0 Trimmer	3296W 10k Trimmer

start here

Website: www.advancepanda.com

Office address: RmA00,5th Floor,Hua Yun Building-1,

Zhen Xing Rd.,FutianDistrict,Shenzhen City,China.







Tel:+852-65782642



Classification	Potentiometers		
			
Description	3590S-2-103L Multi-turn	3590S-2-203L Multi-turn	3590S-2-102L Multi-turn
			
Description	3590S-2-202L Multi-turn	3590S-2-503L Multi-turn	3590S-2-502L Multi-turn

start here







Classification	Switch		
			
Description	Massuse Switch MTS102	Massuse Switch MTS202	Massuse Switch MTS103
			
Description	Massuse Switch MTS203	4x28mm High Voltage 220V Reed Switch	Magnetic Reed Switch 2x14mm

start here

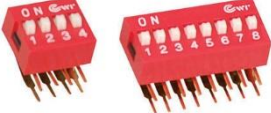
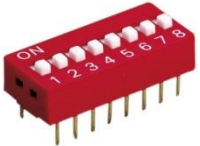



Classification	Switch		
			
Description	10 poles Dip Switch Red	8 poles Right Angle Red	8 Poles Dip switches Red
			Coming soon
Description	6 poles Right Angle Dip Switches Red	4 poles Right Angle Dip Switches Red	2 poles Right Angle Dip Switches
			
Description	2 Poles Dip switches Red	2 poles Dip switches Blue	







start here

Website: www.advancepanda.com

Office address: RmA00,5th Floor,Hua Yun Building-1,
Zhen Xing Rd.,FutianDistrict,Shenzhen City,China.

Tel:+852-65782642



Classification	Switch		
		 <p>Microswitch 5A 125 30v~10T85</p>	
Description	7*7mm 6Pin Push Tactile Power Micro Switch	AC 125V 5A Hinge Lever Micro Limit Switch	5A 250V micro switch
		 <p>Microswitch 1A 125v AC</p>	 <p>Microswitch 2A 125VAC</p>
Description	Micro Switch DM3-03P-25	Microswitch 1A 125VAC	SPDT 2 Position Momentary Micro Limit Switch 2A 125VAC

start here



Classification	Cable		
			
Description	wrapping wire - brown	wrapping wire - gray	wrapping wire - red
			
Description	wrapping wire - violet	wrapping wire - blue	wrapping wire- green
			
Description	wrapping wire - yellow	wrapping wire - black	wrapping wire- white



start here

Website: www.advancepanda.com

Office address: RmA00,5th Floor,Hua Yun Building-1,
Zhen Xing Rd.,FutianDistrict,Shenzhen City,China.

Tel: +852-65782642



Classification	Cable		
			
Description	1x40 Pin 2.54mm Pitch Straight Single Row PCB Female Headers	1x40 Pin 2.54mm Pitch Straight Single Row PCB male Headers	Male Headers 2x40pin - pitch 2.54mm Straight
			
Description	Pin Header female 1 x 40 Pin Pitch=2 straight	2x40 Pin 2.54mm Pitch Double Row PCB Pin Headers	2x40P 80 Pin 2.54mm Pin Header Male dual row Right Angle 90 degree SMT PCB Mount
			
Description	20cm 40 Pin Female to Female Breadboard Jumper Wires Ribbon Cable	20cm 40 Pin Male to Female Breadboard Jumper Wires Ribbon Cable	20cm 40 Pin Male to Male Breadboard Jumper Wires Ribbon Cable

start here





Classification	Cable		
	Coming soon		Coming soon
Description	JUMPERS-FM-300MM	200mm 40 Pins Male Male Splittable Dupont Breadboard Jumper Wires For Arduino	JUMPERS-FF-MM-FM-200MM
			Coming soon
Description	200MM F/F 40 PIN JUMPER WIRE	Breadboard Jumper Wire 75pcs pack	Breadboard Jumper Wire 65pcs pack
	Coming soon	Coming soon	Coming soon
Description	Breadboard Jumper Wire 40pcs pack	Breadboard Jumper Wire 140pcs pack	2.54mm Male Pin Header Connector 2x40P Double Row Straight Needle

start here





Classification	Fuses		
			
Description	Fuses 5x20mm -0.5A	Fuses 5x20mm -1A	Fuses 5x20mm -2A
			
Description	Fuses 5x20mm -3A	Fuses 5x20mm -5A	Fuses 5x20mm -6A
			
Description	Fuses 5x20mm -10A	Fuses 5x20mm -15A	Fuses 5x20mm -20A



start here

Website: www.advancepanda.com

Office address: RmA00,5th Floor,Hua Yun Building-1,
Zhen Xing Rd.,FutianDistrict,Shenzhen City,China.

Tel:+852-65782642









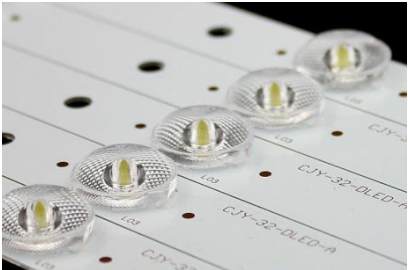

Classification	Fuses		
	<h2>Coming Soon</h2>		
Description	FSMD010-1210 100mA; 60V	FSMD010-1812 100mA; 60V	RXEF135

start here











Classification	LED		
			
Description	LED TV – LED Strips (CJY – 32 – DLED – B) – 7 LEDs	WS2812B	LED CJY15H118C
			
Description	5050 SMD LED WHITE	5050 SMD LED Red	5050 SMD LED Blue
			
Description	5050 SMD LED Green	3528 SMD LED White	3528 SMD LED Green

start here



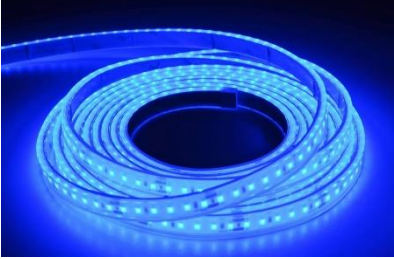

Classification	LED		
			
Description	3528 SMD LED Blue	3528 SMD LED Red	2835 SMD LED WHITE
			
Description	LED 2835 GREEN	2835 SMD LED Blue 0.2W	2835 SMD LED Red 0.2W

start here



Website: www.advancepanda.com

Office address: RmA00,5th Floor,Hua Yun Building-1,
Zhen Xing Rd.,FutianDistrict,Shenzhen City,China.









Tel:+852-65782642



Classification	LED		
			Coming soon
Description	Smart SMD RGB LED APA102-2020	3014 SMD LED Chip cold White Ultra Bright 0.1W	SMD 3535 Infrared Led Diode
	Coming soon	Coming soon	Coming soon
Description	Red 3mm LEDs Round DIP 4.1mm	Pure green 3mm LEDs Round DIP 4.1mm	Yellow 3mm LEDs Round DIP 4.1mm
	Coming soon	Coming soon	Coming soon
Description	UV LED 10W	UV LED 20W	UV LED 30W
	Coming soon	Coming soon	Coming soon
Description	UV LED 50W		

start here

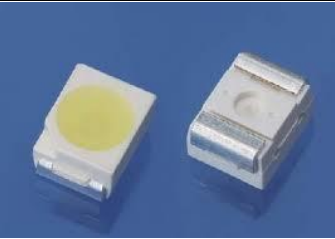

Classification	LED		
			
Description	LED yellow colour 3mm	LED red colour 3mm	LED green colour 3mm
			
Description	LED White 4.8 mm. FYL-4813 UWC / S, 120 ° FORYARD	Led blue colour 3 mm	LED 4.8mm Red TT-4813 UBC
			
Description	LED 4.8mm BLUE TT-4813 UBC	3528 SMD LED 7-8lm	3528 SMD LED 8-9lm

start here

Website: www.advancepanda.com

Office address: RmA00,5th Floor,Hua Yun Building-1,

Zhen Xing Rd.,FutianDistrict,Shenzhen City,China.

Tel:+852-65782642





Classification	LED		
	Coming soon	Coming soon	Coming soon
Description	0603 SMD LED Blue	0603 SMD LED warm white	0805 SMD LED Yellow
	Coming soon		
Description	1206 LED SMD Jade Green Light LED Diode	1W LED High Power Fluorosilicon 6500K PCB Mount (White)	2835 3V 1W 100LM LG for LCD TV LATWT470RELZK
			
Description	2W 6V 3535 LED SMD For LG For Innotek	3030 SMD LED	

start here



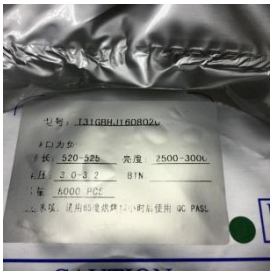

Classification	LED		
			
Description	3014 SMD LED Green	3014 SMD LED White	3014 SMD LED Yellow

start here













Classification	Terminal		
			
Description	FQ14-2ZPJ-6S Round FQ Sealed Connectors	FQ14-4TJ-7 Round FQ Sealed Connectors	FQ14-7TJ-8 Round FQ Sealed Connectors
			
Description	FQ14-7ZK-S Round FQ Sealed Connectors	FQ14-9TJ-8 Round FQ Sealed Connectors	FQ14-9ZK-S Round FQ Sealed Connectors
			
Description	Shielded USB Type B Female Port 4 Pins	USB 4-Pin Female Socket Right Angle Connector	USB Connector 3.0 Female Double stack Dip Type

start here





Classification	Terminal		
			
Description	USB Connector A Type, Plug and Crimping Tail	USB Connector Type C plug	usb connector (Black)
			
Description	USB FEMALE THT horizontal	USB Female Type B Vertical Connector	USB-A female connector A type Female Solder 180 degrees vertical
			 <i>Made USB-A with cover of</i>
Description	OB2 16 Pin Connector Diagnostic Adapter	Micro USB 5 Pin T Port Male Plug Socket Connector&Plastic Cover	Type A Male USB 4 Pin Plug Socket Connector With Black Plastic Cover





start here



Classification	Terminal		
			
Description	10 Pin IDC Right Angle Header IDC Connector	16 Pin Right Angle Male Pitch 2.54mm Shrouded PCB IDC Socket Box Header IDC Connector	16-Pin Straight Box Header Connector IDC Male Sockets 2.54mm IDC Connector
			
Description	20Pin Box Header IDC Socket Straight Male Connector IDC Connector	28 Pin 2.54mm DIP Square Hole IC Sockets Adapter Connector	8 Pin 2.54mm DIP Round Hole IC Sockets Adapter Connector
			
Description	8 Pin 2.54mm DIP Square Hole IC Sockets Adapter Connector	DC 2.1mm Power socket	standard 220v AC male connector

start here







Classification	Terminal		
			
Description	KF350 3pin Blue color	KF350 2pin Blue color	KF350 3pin Green color
			
Description	KF350 2pin Green color		

start here











Classification	HC-49US Low Profile Crystal		
			Coming soon
Description	HC-49US 11.0592MHz	HC-49US 7.3728MHz	HC-49US 16.00MHz
	Coming soon		Coming soon
Description	HC-49US 3.579545 MHz	HC-49US 12.00MHz	HC-49US 16.00MHz
			
Description	HC-49US 8MHz		

start here





Classification	Measuring Instrument		
			
Description	.36" DC 4.5-30V Red Blue Green LED Ampere Panel Voltage Meter Mini Digital Voltmeter Tester	0.36" DC 0~30V Digital Voltmeter Gauge Tester Blue LED Display Panel Mount Car Motorcycle Battery Monitor Volt Voltage Meter	0.56" Red DC 4.5-120V Digital Voltmeter Voltage Measurement 2 Wires Gauge LED Panel
			
Description	3 Digits 0.56" 3 Wire Dc 0-100v Green Led Digital Voltmeter Voltage Display Module with Reverse Protection	Digital Voltmeter 70V to 500V 0.56 inch LED Digital Panel Meter Voltage tester	Digital LCD Probe Fridge Freezer Thermometer Thermograph for Aquarium Refrigerator Black

start here











Classification	Measuring Instrument		
			
Description	Digital LCD Probe Fridge Freezer Thermometer Thermograph for Aquarium Refrigerator Black-1m	LCD AC Digital Voltage meter Voltmeter 80-300V Switch EURO 2 Round Plug Volt Power Monitor AC Panle Meter blue backlight	DC12-24V LCD Display Digital Voltmeter Waterproof LED Volt Meter Gauge Voltage meter
			
Description	Car Digital Monitor LCD Cigarette Lighter Voltage Panel Meter	V2.0 USB Digital Volt Voltage Current Meter Ammeter Rotation Display Detector Charger for Universal Phones Power	PZEM-021 20A AC Digital LED Power Panel Meter Monitor

start here



Classification	Measuring Instrument		
			
Description	DC-100V-10A-Voltmeter-Ammeter -Blue-Red-LED-Amp-Dual-Digital- Volt-Meter-Gauge	Black 300-500V 200A AC Voltmeter Ammeter Digital LCD Panel Monitor Amp Volt Meter With AC Current Transformer	LED V20D DC 4.5-30V two wires Green Digital Measuring Instrument module 0.36 "LED Voltage Meter
			
Description	LED V20D DC 4.5-30V Red Digital Measuring Instrument module 0.36 "LED Voltage Meter	LED V20D DC 4.5-30V two wires Green Digital Measuring Instrument module 0.36 "LED Voltage Meter	V27D 2-wire Digital DC2.7-30V Voltage Meter Green Self-Powered

start here









Classification	Measuring Instrument		
			
Description	V27D-T1 0.56" 3-Digital DC 3.2-30V Voltage Meter LED Voltmeter	LED V20D DC 4.5-30V Blue Digital Measuring Instrument module 0.36 "LED Voltage Meter	V27D-T1 0.56" 3-Digital DC 3.2-30V Voltage Meter LED Voltmeter-Blue
			
Description	DP50V5A Constant Voltage current Step-down Programmable Power Supply module buck Voltage converter color LCD voltmeter	USB Charger Doctor - In-line Voltage and Current Meter	KWS-V20 USB current voltmeter USB tester USB mobile power capacity tester

start here







Classification	Measuring Instrument		
			
Description	LCR-T4 ESR Meter Transistor Tester	0.36 inch three-wire DC 0-100C RED	0.36 inch two-wire DC2.5-30V
			
Description	0.28 inch 4 digitals DC 0-500v	C20D DC 0-5A 0.36INCH	C20D DC0-1000mA (0-1A) 0.36 INCH

start here



Classification	Measuring Instrument		
			
Description	C27D DC 0-100A	C27D DC 0-50A	C68A AC 0-50A
			
Description	V38D TWO WIRE DC 2.5-30V	V40D TWO WIRE DC 15-120V WATER PROOF	V40D TWO WIRE DC 2.5-30V WATER PROOF
			
Description	V56D DC 0-100V WATER PROOF	V56D DC 2.5-30V WATER PROOF	V56D DC 4.5-150V WATER PROOF



start here



Classification	Measuring Instrument		
			
Description	V68A AC 0-600V	V75D DC 0-100V	V85A AC 60-500V two wire
			
Description	12864 128X64 LCD Transistor Tester Diode Triode Capacitance ESR Meter MOS/PNP/	DY294 Digital Transistor Tester	GM328 Lcd Display Transistor Tester ESR Meter Cymometer Square Wave Generator
			
Description	LC100 A Digital LCD Meter	TS-M8N Transistor Tester Diode Triode Capacitance ESR Meter MOSFET NPNPNP	M644 Multifunctional Transistor Tester LCR Resistance Inductance Diode Capacitance ESR Frequency Meter PWM Signal Generator



start here



Classification	Measuring Instrument		
			
Description	Small M8 12864 LCD MEGA328 Transistor Tester Capacitance ESR Meter	RT-219G transistor tester with shell, graphic display resistance inductance capacitance ESR Meter	DIY LCR ESR PWM Graphics Version Transistor Tester

start here



Classification	Sonoff Product		
			
Description	sonoff wifi Refit(Do not include 433 control fuction)	sonoff RF wifi Refit(Include 433 control fuction)	slampher RF (Include 433 control fuction)
	 433mHz 无线遥控器 可控制四路开关		
Description	433mHzRemove control 4pcs button	Sonoff TH10 Temperature Humidity control Refit 10A	Sonoff TH16 Temperature Humidity control Refit 16A
	 线长0.5米 不防水温湿度传感器	 线长1米 防水温度探头	
Description	Sonoff sensor NOT WATERPROOF	Sonoff sensor WATERPROOF ,Length=1 M	Sonoff POW Energy profiler 16A

start here



Classification	Sonoff Product		
			
Description	Sonoff DUAL Refit 10A	sonoff touch EU	sonoff touch US
			
Description	Sonoff 4CH	Sonoff 4CH pro	sonoff T1 uk 1c
			
Description	sonoff T1 uk 2C	sonoff T1 uk 3C	sonoff B1

start here

Website: www.advancepanda.com

Office address: RmA00,5th Floor,Hua Yun Building-1,
Zhen Xing Rd.,FutianDistrict,Shenzhen City,China.





Tel:+852-65782642



Classification	Sonoff Product		
			
Description	sonoff RF bridge New version	sonoff waterproof case	broadlink wifi smart socket MINI3
			
Description	broadlink wiFI box fa1	RM mini3	RMPRO
			
Description	T1 EU 1C	T1 EU 2C	s31

start here









Classification	Sonoff Product		
			
Description	4ch ProR2	4CHR2	S20 EU wifi smart socket Type F
			
Description	S20 EU wifi smart socket Type E	Model: 4ch	

start here







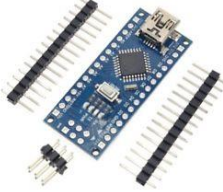

Classification	Arduino		
			
Description	Arduino MEGA2560 R3	Arduino MEGA2560 R3 Original 2012 version ATMEGA16U2	Arduino MEGA2560 R3 Revised CH340G
			
Description	Arduino Pro Mini ATMEGA328P 5V/16M	Arduino Pro Mini ATMEGA328P 3.3V/8M	Arduino Leonardo R3 Original ATMEGA32U4
			
Description	Arduino Pro Micro Mini Leonardo ATMEGA32U4 5V/16M	Arduino UNO R3 Original ATMEGA328PU	Arduino UNO R3 ATEMG328P CH340G

start here









Classification	Arduino		
			
Description	Arduino nano V3.0 ATMEGA328P	Arduino nano V3.0 ATMEGA328P (Without USB) No welding	Arduino Due 2012 R3 ARM
			
Description	Arduino Due 2012 R3 AT91SAM3X8E ARM32 bit for arduino	Arduino Leonardo R3 Orginal ATMEGA32U4	Arduino MEGA ADK 2560 ADK Compatible Arduino Google ADK 2012

start here











Classification	Raspberry Model		
			
Description	Raspberry Pi 2 Model B	Raspberry Pi 2 Model B, Noobs,Black Case	Raspberry Pi 3 Model B SBC
			
Description	Raspberry Pi 3 Model B SBC (Bulk)	Raspberry Pi Model A+	Raspberry Pi Model B+

start here



Classification	Module		
			
Description	ProtoShield Robot Prototype	New cnc shield v3 engraving machine / 3D Printer / A4988 driver expansion board	Screw Shield V1 terminal expansion board is compatible UNO R3 MEGA328P with usb cable
			
Description	NANO V3.0 Prototype Shield and UNO	V5.0 Sensor Shield expansion board for arduino electronic building blocks robot accessories Sensor Shield V5 expansion board	electronic building blocks MOS tube FET driver module IRF520 drive module board (C3B3)

start here







Website: www.advancepanda.com

Office address: RmA00,5th Floor,Hua Yun Building-1,
Zhen Xing Rd.,FutianDistrict,Shenzhen City,China.

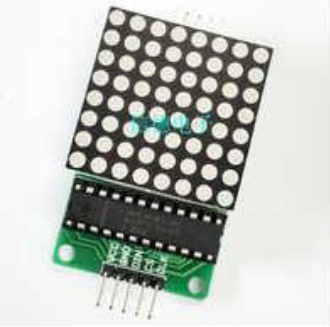
Tel:+852-65782642









Classification	Module		
			
Description	DIY kits MAX7219 dot matrix display module module single chip microcomputer control module--YXDZ2	MAX7219 Dot Matrix Module DIY Kit SCM Control Module For Arduino	Active Buzzer Low Level Trigger Alarm Module
			
Description	MEGA2560/1280 ProtoShield V3 (including breadboard)	AVR microcontroller download USBtinyISP download manager dedicated USB interface cable for arduino	MG995

start here









Classification	Module		
			
Description	Micro Servo Motor MG90S	SG90	Tester
			
Description	TMB12A05	Adjustable Anti Static Bracelet Electrostatic ESD Discharge Cable Reusable Wrist Band Strap Hand With Grounding Wire	DHT22(AM2302)

start here



Classification	Module		
			
Description	HP203B PRECISION BAROMETER AND ALTIMETER	LINK-V2	TP4056
			
Description	TS801 LED Sending Card		Waterproof DS18B20 Temperature Sensor Temperature Transmitter 1m

start here





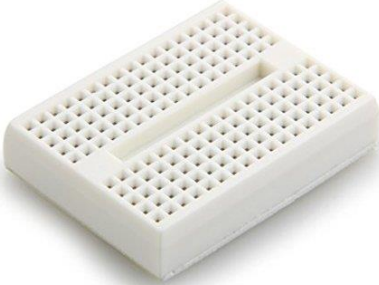





Classification	Module		
			
Description	Yellow-Wheel-600x600	ZY-170 Mini Solderless Prototype Breadboard for Arduino Shield White	

start here



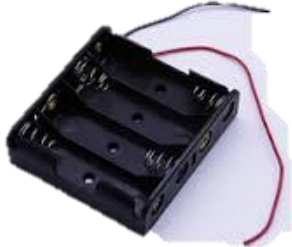





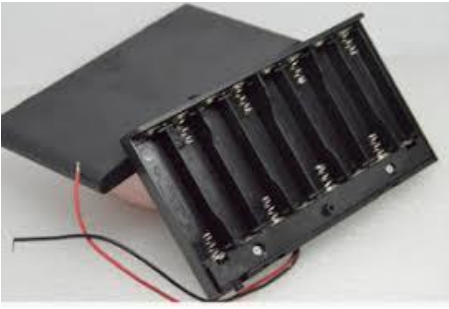

Classification	Power source holder Module		
			
Description	1 Section DC Head Battery 1.5V Volt No Cover Strip	2 section DC Head Battery size AA	2 section DC Head Battery size AA 3V without Cover
			
Description	2 section DC Head Battery box size AAA	4 section DC Head Battery with no cover switch battery box	6 section DC Head Battery Box with lid switch Red black line size AA







start here



Classification	Power source holder Module		
			
Description	8 section DC Head Battery Box with lid switch Red black line	8 Section DC Head Battery Box with Cover	Fully Sealed with Switch Battery Boxes 3 Sections DC Head Battery AA size
			
Description	Fully Sealed with Switch Battery Boxes 3 Sections DC Head Battery AAA size	Fully Sealed with Switch Battery Boxes 6 Sections DC Head Battery AA size	Fully Sealed with Switch Battery Boxes 4 Sections DC Head Battery AA size

start here







Classification	Power source holder Module		
			
Description	A23L 23A 12V battery compartment Battery compartment	18650 Battery Box Lithium Battery 1 section Box	18650 Battery Box Lithium Battery 2 section Box 7.4V
			
Description	18650 Battery Box Lithium Battery 3 section Box 11.1V	18650 Battery Box Lithium Battery 4 section Box 14.8V	6 section DC Head Battery Box with lid switch Red black line size AA

start here









Classification	Power source holder Module		
			
Description	9V Battery Box Universal Battery Holder with DC Plug Line	9V Battery Box Universal Battery Holder	SMD 18650 Smoking battery Box 1 section
			
Description	SMD 18650 Smoking battery Box 2 section		

start here





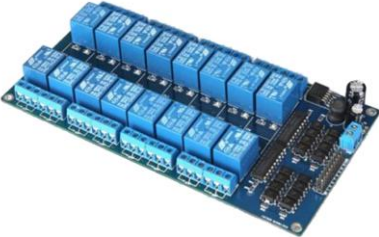



Classification	Channel Relay Module		
			
Description	Relay Module 5V - 1 channel	Relay Module 5V - 2 channel	Relay Module 5V - 4 channel
			
Description	Relay Module 5V - 8 channel	Relay Module 5V - 16 channel	



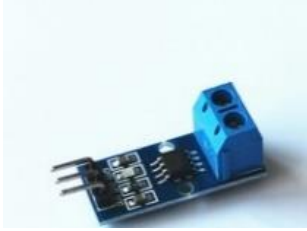

start here



Classification	Sensor Module		
			
Description	SW-420 Motion Sensor Module Vibration Switch Alarm	Whistle Module Voice Control Switch Output High Low Level and low level DIY	DS18B20 temperature measurement sensor module
			
Description	5A Range Hall Current Sensor Module ACS712ELCTR-05A Module For Arduino 5A	Waterproof Ultrasonic Module FYD-SR04 Water Proof Integrated Distance Measuring Transducer Sensor	UV Detection Sensor Module Ultraviolet Ray Module For Arduino Sensor



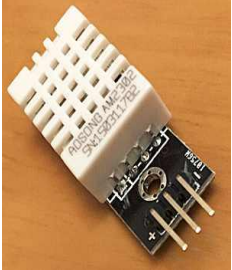



start here



Classification	Sensor Module		
			
Description	flame sensor infrared optical receiver test fire	DS18B20 Module Single Bus Digital 18B20 Temperature Sensor	DS18B20 Waterproof Digital Temperature Probe Thermometer Stainless Steel Housing Sensor 1m Long Cable Moistureproof
			
Description	DHT22 Single Bus Temperature Humidity Sensor	DHT11 Temperature And Relative Humidity Sensor	DHT12 digital temperature and humidity sensor





start here



Classification	Sensor Module		
			
Description	Touch Sensor Module YFRobot Tact Switch Touch Switch Sensor	Voltage Detection Module Voltage Sensor Voltage Sensor	detect soil moisture sensor module
			
Description	4-way infrared tracking sensor	TTP224 4 channel digital capacitive touch switch	TTP224 8 channel digital capacitive touch switch

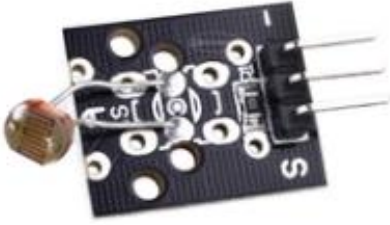





start here



Classification	Sensor Module		
			<h2>Coming Soon</h2>
Description	TTP224 16 channel digital capacitive touch switch	KY-018 3pin Optical Sensitive Resistance Light Detection Photosensitive Sensor	DS1820 Stainless steel package Waterproof
			
Description	HR31 hygrometer HR202L humidity sensor	KY-008 650nm sensor	Infrared barrier module adjustable distance photoelectric switch







start here

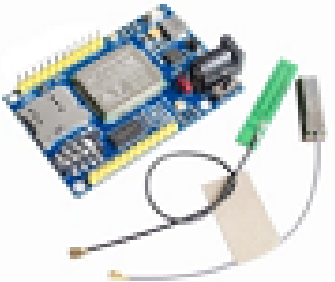

Classification	Sensor Module		
			
Description	Level Sensor Water Droplet Detection Depth	High-sensitivity microphone sensor module KY-037 MJT	LASER Proximity Sensor
			
Description	Touch Sensor Module Touch Switch Touch Switch Sensor 1 Way	RCWL-0516	HC SR501 PIR Sensor Human Body detecting module Pyroelectric

start here

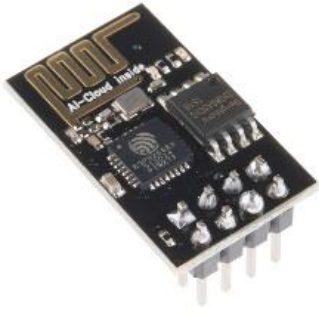







Classification	Module		
			
Description	Raindrops Detection Sensor Weather	FM Radio Transmitter V2.0 70-108Mhz Module Radio Station Transmitter	Wireless Module A7 GSM GPRS GPS 3 in 1 Module Shield DC 5-9V for Arduino STM32 51MCU Support Voice Short Message
			<p>superheterodyne 433Mhz RF receiver Module</p>  <p>1 set for MCU/ARM/Arduino</p> <p>Short Antenna For Transmitter</p> <p>Long Antenna For Receiver</p> <p>433Mhz RF transmitter Module</p>
Description	TEA5767 FM Stereo Radio Module Arduino 76-108Mhz With Free Antenna	ESP8266 serial WIFI wireless module wireless transceiver ESP-01	433Mhz RF Transmitter and Receiver Link Kit for Arduino/ARM/MCU WL

start here











Classification	Module		
			
Description	RFID 13,56Mhz	RFID module RC522 Kits S50 13.56 Mhz 6cm With Tags SPI Write & Read uno 2560	Biaxial joystick button control lever sensor PS2 games
			
Description	ECG-EMG Arduino Shield (Bio-feedback sensor)	Mini Data Logger Module Logging Shield for Arduino For Raspberry Pi Logging Recorder Data Logger Module Shield V1.0 SD Card	Tag RFID (13.56 MHz)

start here











Classification	Module		
			
Description	HC-SR04 Blue	ultrasonic sensor HC-SR04	Mini MP3 Player Module with Simplified Output Speaker for Arduino for UNO
			
Description	1602 LCD Adapter Plate IIC I2C / Interface lcd1602 I2C LCD Adapter	3S 10A 12V Lithium Battery Charger Protection Board Module for 3pcs 18650 Lipo Li-ion Battery Cell Charging BMS 11.1V 12.6V	4 Channel IIC I2C Logic Level Converter Bi-Directional Module 5V to 3.3V Tool







start here



Classification	Module		
			
Description	5V DC Delay Relay Delay with Timer Turn on / Delay Turn off Switch Module	ATTINY85 General Micro USB Development Board	Barcode Scanner (USB interface)
			
Description	Fingerprint Recognition Module FPM10A Optical Fingerprint For Arduino	GL100A 1600V	I2C Wii WiiChuck Nunchuck Adapter shield Module Board for Uno





start here



Classification	Module		
			
Description	IR Detector	KY-040 Rotary Encoder Module Brick Sensor Development for Arduino AVR PIC 360 Degree Rotation	RS232 to RS485 converter RS232 to 485 two-way converter passive rd232 to 485 module(E4A2)
			
Description	LJ12A3-4-Z/BX ,NPN,3-wire NO,diameter 12mm,Proximity Switch	RAMPS 1.4 3D printer controller panel	Roarkit pulsesensor heart rate for Arduino open source

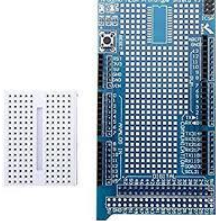





start here

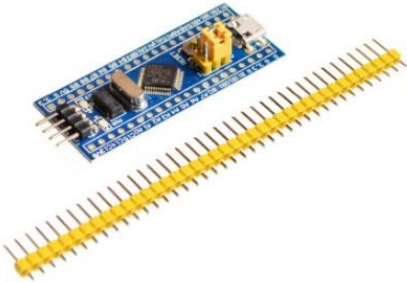

Classification	Module		
			
Description	download USBtinyISP download manager dedicated USB interface cable for arduino	MEGA2560/1280 ProtoShield V3 (including breadboard)	Active Buzzer Low Level Trigger Alarm Module
			
Description	DIY kits MAX7219 dot matrix display module module single chip microcomputer control module--YXDZ2	MAX7219 Dot Matrix Module DIY Kit SCM Control Module For Arduino	W1209 Mini thermostat Temperature controller Incubation thermostat temperature control switch

start here



Classification	Module		
			
Description	STM32F103C8T6 the smallest board -Cortex-M3 - STM32	Wireless module CH340 NodeMcu V3 Lua	8 relay module with IR remote control
			
Description	BEC voltage adapter with one output	BMS Module of protection of 3 elements 18650 with balancing HX-3S-FL25A-A	GPIO adapter for contact plate + tape

start here





Classification	Module		
Description	Limit Switch ME8169 (AH8169)	Mini Pump for liquid 12V 120Lmin, 15W	Mini USB port for the prototype board
Description	NPN TL-W5MC1 inductive sensor	Battery charge control module 12V with indicator	electronic Kit stereo wireless FM radio receiver PCB 76~108MHz for assemble







start here



Classification	Module		
		<p>Makeboard</p> 	
Description	LM1036N Fever Volume Control Board Kit for 12v	Micromake 3D Printer Parts Makeboard Pro 3D Printer Main Board Support Heatbed Compatible with Ramps 1.4	TL-Smoother DFORCE 3D
			
Description	Duinopeak ECG/EKG/EMG Shield	RGBZONE 12-24V 24 Keys Iron Shell Wireless IR Remote Control Music Sound Controller for RGB LED Strip Light	







start here



Classification	USB To TTL Module		
			
Description	Basic program downloader USB to TTL FT232RL support 3.3V 5V	TEA5767 module	MAX3232 RS232 to TTL module
			
Description	U7 STC Automatic Download Line Offline Downloader Microcontroller Programmer	PICKIT3.5 Programmer Offline Programming Simulation PIC	CH376USB interface communication U disk module

start here



Classification	USB To TTL Module		
			
Description	FT232RL USB to TTL	STM32 MCU STC Cold Start Downloader USB to TTL	New FT232 Original Chip USB to RS485 Module
			
Description	CH340G instead of PL2303 USB to TTL	USB2.0 print line	FT232RL MWC debugger USB to TTL

start here











Classification	USB To TTL Module		
			
Description	FT232 to TTL	HL-340 USB-RS232 USB 9 serial cable	PL2303HX USB to TTL RS232 module upgrade module USB to serial
			
Description	RS232 module upgrade module PL2303TA download line USB to TTL	Mini2440/OK6410/tiny6410 USB to RS232 cable	PL2303HX Module STC Microcontroller USB to TTL





start here



Classification	USB To TTL Module		
			
Description	RS232 to TTL module	XBee/Bluetooth Bee Adapter USB Adapter	USB to RS485
			
Description	MAX485 module	Mini RS232 MAX3232 level to TTL	MCU2012 CP2102 USB transfer TTL communication module Mini recorder Downloader

start here







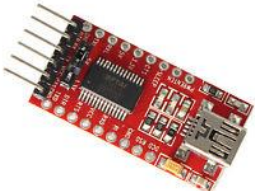

Classification	USB To TTL Module		
			
Description	3.3V 5V FT232RL module miniusb board	FT232RL FTDI Basic USB to serial for pro mini download cable USB TO 232 FT232	PL2303HX module Download line on STC microcontroller
		 RFID	
Description	HC-05	ST LINK Stlink ST-Link V2 Mini STM8 STM32 Simulator Download Programmer Programming With Cover	

start here









Classification	USB Module		
			
Description	FT232RL	FT245RL	Serial Chip-CH340G
			
Description	USB Detector	USB to RS485 converter	usbasp

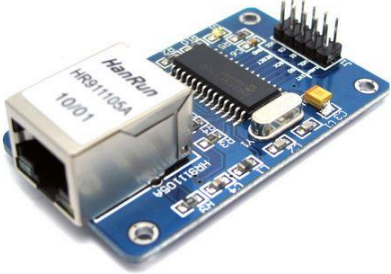





start here



Classification	Ethernet module		
			
Description	ENC28J60	Ethernet Shield W5100 for Arduino UNO R3 Mega 2560 1280 A057	Wiznet WIZ820io
			
Description	W5500 Ethernet		







start here



Classification	Display module		
			
Description	3.5-inch TFT LCD Module	LCD1602 Character LCD Screen Input/Output Expansion Board LCD Keypad Shield	Graphic LCD 84x48 - Nokia 5110
			
Description	5110 screen LCD module	2.8-inch TFT LCD touch screen with color touch	LCD OLED 128x32 0,91'

start here



Classification	Display module		
			
Description	3.2 inch TFT LCD module with touch color 65K	3.2 inch TFT LCD screen color module 240X400	0.96 inch white 128*64 OLED LCD display module
			
Description	2.4 inch TFT LCD touch screen color module	1.44 inch TFT SPI serial port LCD color display	2.0 inch TFT LCD screen module

start here









Classification	MQ Series Module		
			
Description	MQ-2 Smoke Gas Sensor	MQ-3 alcohol sensor module ethanol gas detection alarm for Arduino	MQ-4 natural gas methane sensor module
			
Description	MQ5 Methane Natural Gas Sensor	MQ6 LPG Gas Sensor Module Liquefied	MQ-8 Hydrogen Gas Sensor Detection Alarm Module

start here



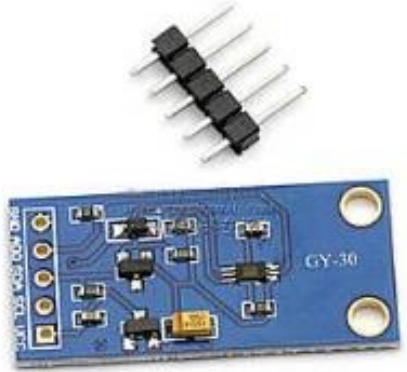

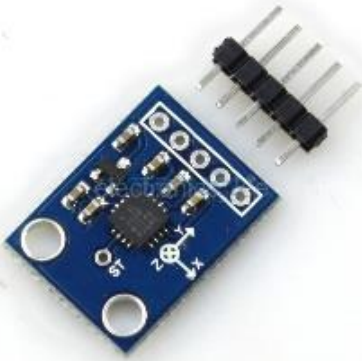
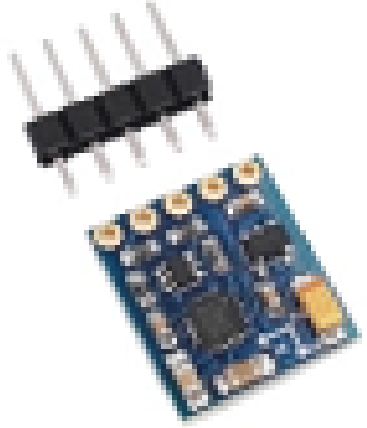

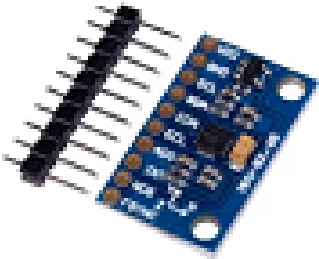

Classification	GY Series Module		
			
Description	GY-273 HMC5883L Triple Axis	GY-50 L3G4200D 3 Axis Digital Gyroscope	GY-30 digital intensity light sensor BH1750FVI
			
Description	GY-31TCS230 TCS3200 color sensor/color	GY - 61 ADXL335 module	GY-271 Axis Digital Compass (HMC5883L)

start here

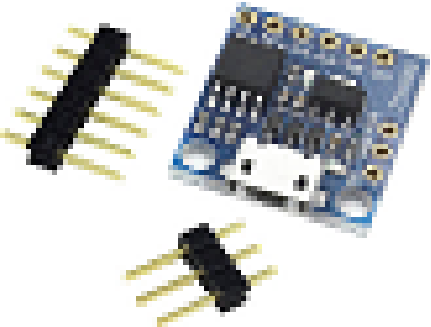





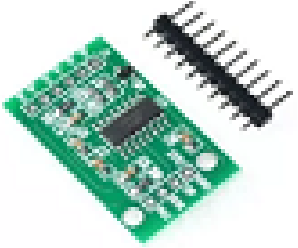

Classification	GY Series Module		
			
Description	GY-9255MPU 9255 (3 Axis Gyroscope + 3 Axis Acceleromter + 3 Axis Magnetometer)	GY-68 BMP180 Replace BMP085 Digital Barometric Pressure Sensor Board Module for Arduino 1.8-3.6V Power	ATTINY85 Module Digispark kickstarter Micro development board for Arduino usb
			
Description	GY Attiny85 Digispark kickstarter Mini USB Development Board Module Tiny85		

start here







Classification	Power Supply Module		
			
Description	HX711 Weighing Sensor Dual-Channel 24 Bit Precision A/D Module Pressure Sensor	New Snap on 9V (9 Volt) 6F22 Battery Clip Connector Hard Shell I Model	Booster step up module-LTC1871
			
Description	MP1584	5A DC to DC CC CV lithium Battery Step down Charging Board Led Power Converter Lithium Charger Step	5A Adjustable Power DC-DC Step-down Charge Module LED Driver With Voltmeter

start here











Classification	Power Supply Module		
			
Description	LM2596 DC-DC Step Down Power Supply Module LED Driver Battery Charger Adjustable LM2596S Constant Current Voltage	LM2596S	LM2596 Voltage Regulator Module with display
			
Description	DC-DC Step Down High Voltage(Max 60V) 3A - LM2576HV	DC-DC Boost Converter DC DC Step Up Converter Module Adjustable Static Power Voltage Regulator 10-32V to 12-35V Step Up 150W 6A	MT3608 MAX 2A Output 28V DC-DC Step Up Converter Booster Power Apply Module Booster Power Module For Arduino

start here







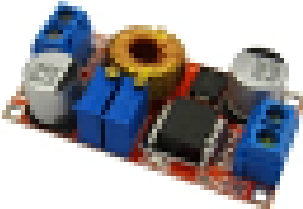

Classification	Power Supply Module		
			
Description	EasyDriver Shield stepping Stepper Motor Driver V44 A3967 B02	DC-DC USB 0.9V-5V TO 5VDC BOOST STEP-UP POWER SUPPLY MODULE MINI PFM CONTROL	L298 DUAL MOTOR DRIVER
			
Description	5A Constant Current/ Voltage LED Driver Battery Charging Module Voltmeter Ammeter TK1210	LM317 DC-DC step down DC Converter Circuit board power supply module	Step Down Buck Converter DC CC 9A 300W 5-40V To 1.2-35V - Black

start here











Classification	Power Supply Module		
			
Description	XL4015 XI4015 5A Cc Cv Lithium Charger Dc-Dc Step Down Adjustable Buck Power Module	Reprap Stepper Driver A4988 Stepper Motor Driver Module with Heatsink	AMS1117 3.3V Step down Power Supply Buck Module
			
Description	5V Boost Step Up Power Module Lithium LiPo Battery Charging Protection Board LED Display USB	28BYJ-48 Valve Gear Stepper Motor DC 12V 4 Phase Step Motor Reduction Arduino	28BYJ-48 Valve Gear Stepper Motor DC 12V 4 Phase Step Motor Reduction Arduino

start here











Classification	Power Supply Module		
			
Description	DC MOTOR 3V-6V	MP2307DN MINI360 Model aircraft power step-down Module DC DC Super Small power supply module	Battery case 6XR6
			
Description	AC 220V 2000W SCR Voltage Regulator Dimming Dimmers Speed Controller Thermostat Electronic Voltage Regulator Module	200V 4000W SCR Dimmer Speed Controller Temperature Voltage Regulator	4000W SCR power AC voltage regulator module







start here



Classification	Power Supply Module		
			
Description	MP1405 5V 1A Li-Battery Micro USB Charger Module	HG-1206W Dual battery charger	HG-1412W Universal Battery Charge
			
Description	NE555 Generator pulse frequency duty cycle adjustable module	Gear Stepper Motor 28BYJ-48 DC 5V ULN2003 Driver Test Module Board For Arduino UNO R3	L293D Motor Driver Shield







start here



Classification	Power Supply Module		
			
Description	TB6600-MODUL-BOX	Step Motor Drive Module TB6560-3A-MODULE	MB102 Breadboard Power Supply Module 3.3V 5V For Solderless Breadboard
			
Description	DC-DC boost module 150W solar battery charging power boost constant current LED driver	XL6009 Boost Step-up Module DC-DC 4.5-32V to 5V-52V + LED Voltmeter DC-DC Boost module with adjustable voltage meter display	DC-DC 4.5-32V to 5V-52V XL6009 Boost Step-up Module Power Supply LED Voltmeter





start here



Classification	Power Supply Module		
			
Description	XL6009 dc/dc step up power supply converter module input 3V-32V output 5V-40V adjustable boost current 4A	30A Mini VNH2SP30 Stepper Motor Driver Monster Moto Shield module For Arduino	TZT teng SA 2 Way DC Motor Driver Module PWM Speed Dural H-Bridge Stepper L298N L9110
			
Description	Monster Moto Shield VNH2SP30 stepper motor driver module high current 30A	2000W traces trimming power module	pwm dc motor speed controller 10A

start here

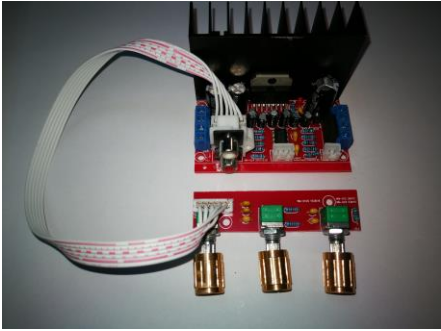
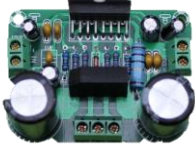

Classification	Power Supply Module		
			
Description	pwm dc motor speed controller 20A	pwm dc motor speed controller 30A	pwm dc motor speed controller 40A
			
Description	TDA7377 Single Power Supply PC Subwoofer Mega Bass 2.1 Amplifier Board	TDA 7293 power amplifier board	TDA7297 power amplifier board

start here